

13LR40-S500+55CM-640-26-H22-T12-C-6

Laser Micro Line Generator with a fan angle



FEATURES

Laser line with a fan angle and approx. uniform intensity distribution.

- Line length: 357 mm
- Line width: 128 μm
- Wavelength: 640 nm
- Working distance: 492 mm

-
- Micro Line Generator for small laser line widths and high power density in the focal plane



DESCRIPTION

The laser diode beam source type 13LR40-S500+55CM-640-26-H22-T12-C-6 has a fan angle of 40° with a constant line width and approx. uniform intensity distribution along the laser line.

The fine-structure is a [chain of equidistant dots](#) with a spacing of approx. the line width. The line width is constant along the laser line. Across the laser line the intensity distribution is Gaussian.

The laser has integrated electronics [type C](#) for control of the laser output power. The output power can be controlled using the [modulation input ports \(TTL and analog\)](#), or manually using the potentiometer.

The working distance can be adjusted by adjusting the focus setting. Please note that beam parameters like line length and line width increase proportionally to the working distance.

A fine-adjustment of the distance between laser and target is recommended for fine-focusing.

TECHNICAL DATA

13LR40-S500+55CM-640-26-H22-T12-C-6

Series	13LR	
Order Code	13LR40-S500+55CM-640-26-H22-T12-C-6	
Line profile	Constant Intensity Distribution	
Line type	Laser Micro Line	
Wavelength	640 +5/-5 nm	
Laser output power	26 mW	
Laser safety class	3B	
Fan angle α	40 deg	
Focussing range	415-815 mm	
Working distance	492 mm	
Line length	357 mm	
Line width	0.128 mm	
Rayleigh range	40 mm	
Edge intensity	80 %	
Diameter laser module	25/28 mm	
Module length	78.4 mm	
Installation length	600.4 mm	
Cable length	1.5 m	
Connector type	Lumberg SV50 IEC 61076-2-106	
Supply voltage	5 ± 0.2 V	
Max. current consumption	0.25 A	
Working temperature	0 - 40 °C	
Modulation inputs	Analog	TTL
Input resistance	22 kOhm	22 kOhm
Max. modulation frequency	100 kHz	100 kHz
Modulation delay ON/OFF	1/0.5 μ s	2/1 μ s
Rise / Fall time	3/2 μ s	3/2 μ s

Dimensions (for a complete dimensional drawing please refer to the downloads section)

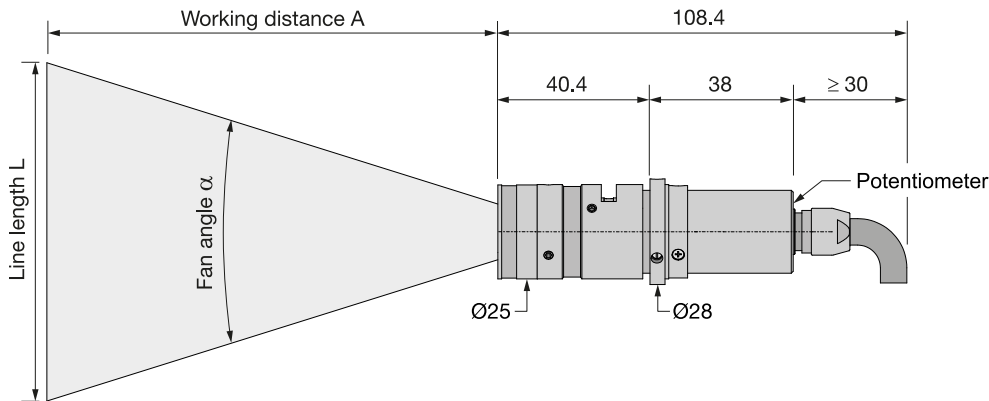

DOWNLOADS



[930412000105.pdf](#)

ACCESSORIES

50HD-15	Hex key WS 1.5
9D-12	Screwdriver WS 1.2
13MK-25-36-10-F	Mounting Console with flat base plate
13MK-25-36-10-M	Mounting Console with base plate with dovetail profile
PS051003E	Power Supply 5 V

RELATED PRODUCTS

LASER MODULES SERIES 13LRM

- Macro Line Generator, fan angle
- Uniform intensity distribution
- Extended depth of focus

LASER MODULES SERIES 13LN

- Micro Line, **small** fan angle
- Uniform intensity distribution
- Thin lines

**LASER MODULES
SERIES 5LM+25CM**

- **Compact** Micro Line, **small** fan angle
- Gaussian intensity distribution

**LASER MODULES
SERIES 5LP+25CM**

- **Compact** Micro Line, **large** fan angle
- Gaussian intensity distribution

**LASER MODULES
SERIES 5LM**

- Micro Line, **small** fan angle
- Gaussian intensity distribution

**LASER MODULES
SERIES 5LP**

- Micro Line, **large** fan angle
- Gaussian intensity distribution

This is a printout of the page https://sukhamburg.com/products/details/13LR40-S500_55CM-640-26-H22-T12-C-6 from 6/1/2023

CONTACT

For more information please contact:

Schäfter + Kirchhoff GmbH

Kieler Str. 212

22525 Hamburg

Germany

Tel: +49 40 85 39 97-0

Fax: +49 40 85 39 97-79

info@sukhamburg.de

www.sukhamburg.com

LEGAL NOTICE

Copyright 2020 Schäfter+Kirchhoff GmbH. All rights reserved.

Text, image, graphic, sound, video and animation files and their arrangement on Schäfter+Kirchhoff GmbH webpages are protected by copyright and other protective laws. The content may not be copied for commercial use or reproduced, modified or used on other websites. [\[more\]](#)