

Line Scan Camera SK8160U3KO-LB

CCD

monochrome

USB 3.0

High resolution digital CCD camera with very high line frequencies



■ Sensor Characteristics

Sensor type:	CCD, Monochrome
Pixel number:	8160
Pixel size:	5 x 5 μm^2
Active sensor length:	40.8 mm
Pixel frequency:	100 / 50 MHz
Max. line frequency:	11.9 kHz
Min. integration time:	0.01 ms
Max. integration time:	20 ms
Spectral range:	350 - 900 nm
Dynamic range:	1:2000 (rms)

■ Mechanical data

Case type:	AT3L
Size:	$\varnothing 65$ mm x 53.7 mm
Mass:	0.2 kg
Lens mount:	M45x0.75
Flange focal length (FFL):	19.5 mm
Seat for bracket:	$\varnothing 47.5$ mm

■ Functioning Features

Blooming protection:	x
Integration control:	x
Shading correction:	x
Look-up table:	x
Region of interest (ROI):	x
Thresholding:	x
Temperature sensor:	x
External synchronization:	x
Operating temperature:	+5 ... +45°C

■ Connections

Interface:	USB 3.0
	Type μB , threaded
Video signals:	monochrome 8/12 Bit digital
Power supply:	+5/+15V DC, 6.5 W
External synchronization:	TTL
(for power supply and external synchronization)	Hirose 10A, 6-pin, male

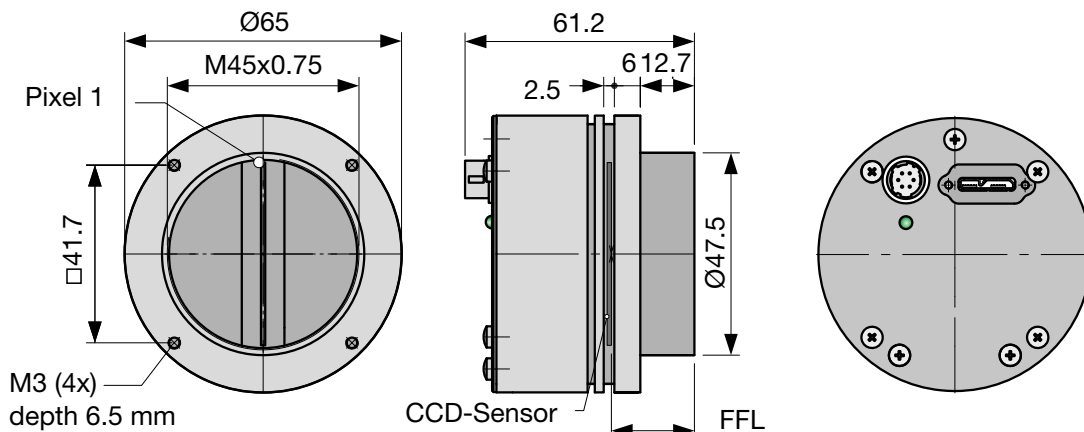

Software

Software

SK91USB3-WIN Order Code

SDK from Schäfter + Kirchhoff including the **SKLineScan** operating program, as well as API, C++ class library and examples.

Operating systems:
Windows 7 / 8.1 / 10 - x64 and x86

SK91USB3-LV VI Order Code

VI-Library for LabVIEW®, requires **SK91USB3-WIN**



Software

SK91USB3-LX Order Code

SDK from Schäfter + Kirchhoff including the **SKLineScan** operating program, as well as libraries and examples.

Operating systems:
Linux kernel 3.13 or higher, compiled for Debian or openSUSE

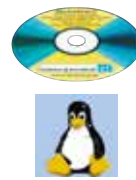

Accessories

USB 3.0 cable SK9020.x

Camera connector: USB 3.0 plug, type micro-B, with safety lock screws

PC connector: USB 3.0 plug, type A (also fits into a USB 2.0 type A socket)

SK9020.x Order Code

└── 3 = 3 m cable length (standard)
 5 = 5 m cable length



Power supply unit PS051515

Input: 100-240 VAC, 0.8 A, 50/60 Hz
IEC 60320 C14 coupler (for IEC C13 power cord)

Output: +5VDC, 2.5 A / +15VDC, 0.5 A / -15VDC, 0.3 A
Cable length: 1 m, with Lumberg connector KV60, female 6-pin

PS051515 Order Code

Power cord IEC 60320 C13, 1.5 m, 10 A, 250 VAC

PC150DE Order Code

└── DE = Europe / US = USA, Canada, Japan /
 UK = United Kingdom



USB 3.0 active extension cable USB3.EXT.AA10

External power supply +5VDC, length 10 m

Connectors:
1x socket USB3.0 socket, type A,
1x plug Power in, 5VDC,
1x plug USB3.0, type A (also fits a USB2.0 type A socket)

USB3.EXT.AA10 Order Code



Combined Synchronization and Power Cable SK9016.1.5

Applicable when a power supply in addition to the USB interface is required. Shielded cable, length 1.5 m.

Connectors: Hirose plug HR10A, female 6-pin, (camera side), Lumberg SV60, male 6-pin connector (for supply voltage), Phoenix 6-pin connector incl. terminal block (for synchronization signals)

SK9016.1.5 Order Code



USB 3.0 active extension cable USB3.EXT.A2A...

Hybrid cable (copper/fiber), power supply by another USB-connection, cable length up to 100 m on request.

Connectors:
USB3.0 plug and socket, with locking screws

USB3.EXT.A2Ax Order Code

└── 20 = 20 m cable length
 30 = 30 m
 50 = 50 m
 other lengths up to 100 m on request



Adapter cable for sync signals CAB-ADSync-BNC-1

BNC/SMA (3x) to line scan camera synchronization cable SK9016/SK9024/SK9026.

Shielded cable, length 0.25 m

Connectors:
1x Phoenix 4-pin connector
3x SMA plug (Line Sync A, Line Sync B, Frame Sync)
3x adapter SMA socket (outside threading) to BNC-plug

CAB-ADSync-BNC-1 Order Code



M2 Mounting Bracket SK5105-L

For cameras with lens thread size M45x0.75

SK5105-L Order Code

SK5105-L with clamping set SK5101#

MC2 Clamping Set SK5101

Clamp **SK5101** Order Code
(set of 4 pcs.)

Allen screw DIN 912-M3x12

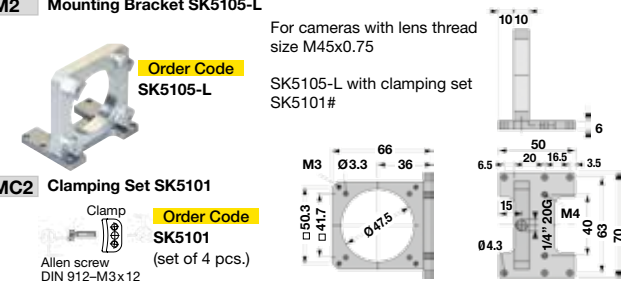

M4 Mounting System SK5105-2L

SK5105-2L Order Code

For camera configurations with tube length > 55 mm using extension rings **ZR-L**

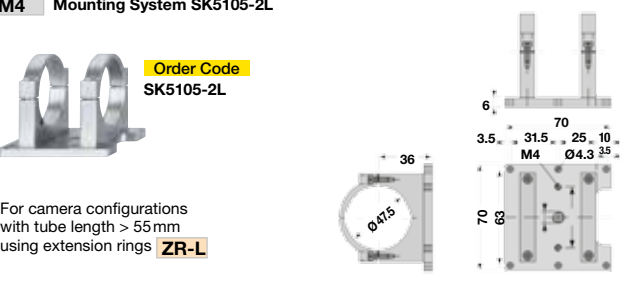

FA3 Focus adapter L-Mount (M39x1/26" Leica)

any rotation angle adjustable (V-groove)
attachment thread M45x0.75, male

FA22R-45 Order Code
length L: 22 ... 32 mm

FA22RL-45 Order Code
length L: 29 ... 38 mm

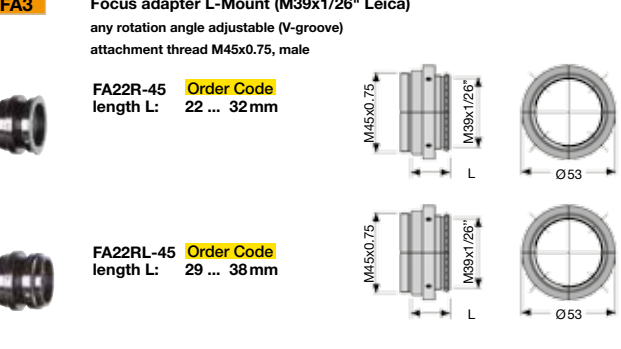

A3 Lens Adapter F-Mount

for line scan cameras with case type **Axx** or **BGx**.

AOC-F-... Order Code

Attachment thread:
45 = M45x0.75
40 = M40x0.75
32 = M32x0.75
C = C-Mount 1"-32-TP



ZR-L Extension rings M45x0.75

attachment threads M45x0.75 male/female

ZR-L.25 Order Code

└── 15 = Length 15 mm
 25 = Length 25 mm
 60 = Length 60 mm
 87 = Length 87 mm

