

Line Scan Camera SK7500GTO-4XL

CCD

monochrome

Gigabit
ETHERNET

Line scan camera with 5.2 kHz maximum line rate, high resolution and high sensitivity.

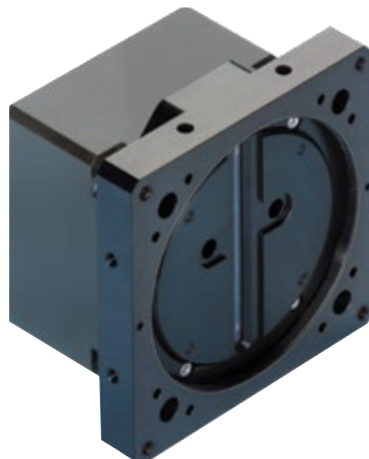

Sensor Characteristics

Sensor type:	CCD, Monochrome
Pixel number:	7500
Pixel size:	7 x 7 μm^2
Active sensor length:	52.5 mm
Pixel frequency:	40 / 15 MHz
Max. line frequency:	5.2 kHz
Min. integration time:	0.01 ms
Max. integration time:	20 ms
Spectral range:	400 - 900 nm
Dynamic range:	1:750 (rms)

Functioning Features

Anti blooming:	-
Integration control:	-
Shading correction:	x
Look-up table:	x
Region of interest (ROI):	x
Thresholding:	x
Temperature sensor:	x
External synchronization:	x
Operating temperature:	+5 ... +45°C

Mechanical data

Case type:	CG5
Size:	84 mm x 84 mm x 62 mm
Mass:	0.3 kg
Lens mount:	M72x0.75
Flange focal length (FFL):	8.2 mm
Seat for bracket:	\varnothing 0 mm

Connections

Interface:	GigaBit Ethernet RJ-45 (8P8C)
Video signals:	monochrome 8/12 Bit digital
Power supply:	24V DC, 3.8 W Hirose 10A, 4-pin, male
External synchronization:	TTL Hirose 10A, 12-pin, male

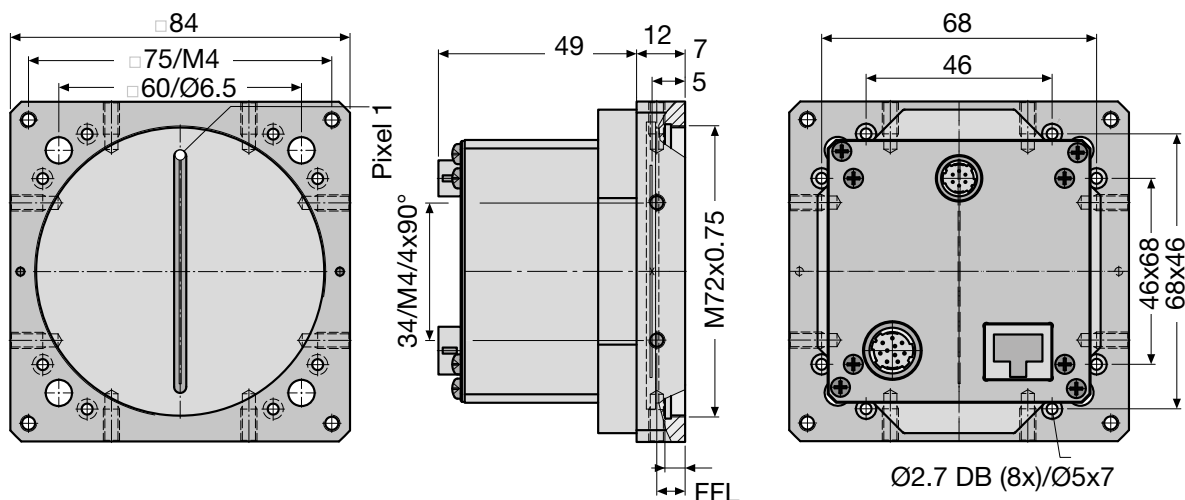

Software



Software

SK91GigE-WIN Order Code

SDK from Schäfter + Kirchhoff including the **SKLineScan** operating program, as well as API, C++ class library and examples.

Operating systems:
Windows 7 / 8.1 / 10 - x64 and x86

SK91GigE-LV VI Order Code

VI-Library for LabVIEW®, requires **SK91GigE-WIN**

Accessories



CAT6 Network cable

Shielded CAT6 patch cable, halogen-free, both ends with RJ45 connectors for Gigabit Ethernet

CAT6.x Order Code

└ cable length 3 / 5 / 10 m or length according to choice, max. 100m



Power supply unit PS243005

Input: 100-240 VAC, 0.8 A, 50/60 Hz
IEC 60320 C14 coupler (for IEC C13 power cord)
Output: +24V DC, 3.0 A
Cable length: 1 m, with XLR connector type NC6FFX

PS243005 Order Code

Power cord IEC 60320 C13, 1.5 m, 10 A, 250 V AC

PC150DE Order Code

└ DE = Europe / US = USA, Canada, Japan / UK = United Kingdom



External synchronization cable SK9024.x

for line scan cameras with GigE / GigE Vision™ interface.

Shielded cable with Hirose plug HR10A, female 12-pin (camera side), and Phoenix 4-pin connector incl. terminal block.

SK9024.x Order Code

└ cable length 3 / 5 m
Other lengths on request



Power cable SK9014.xMF

for GigE Vision™ line scan cameras with 24 VDC supply voltage.

Shielded cable with Hirose plug HR10A, female 4-pin (camera side), and XLR connector type NC6MXX (power supply unit side).

SK9014.xMF Order Code

└ cable length 1.5 / 3 / 5 m



Adapter cable for sync signals CAB-ADSync-BNC-1

BNC/SMA (3x) to line scan camera synchronization cable SK9016/SK9024/SK9026.

Shielded cable, length 0.25 m

Connectors:
1x Phoenix 4-pin connector
3x SMA plug (Line Sync A, Line Sync B, Frame Sync)
3x adapter SMA socket (outside thread) to BNC-plug

CAB-ADSync-BNC-1 Order Code



Power cable SK9014.xF

for GigE Vision™ line scan cameras with 24 VDC supply voltage.

Shielded cable with Hirose plug HR10A, female 4-pin (camera side), and open-ended cable.

SK9014.xF Order Code

└ cable length 1.5 / 3 / 5 m



Focus Adapter FA26-Sx

High-precision adapter with linear tracking rods for precise travel of the focussing encasement and for locking focus position. Focussing range 29 mm, 1 turn of the focussing ring corresponds to 10 mm. Screws for focus locking.

FA26-Sx Order Code

└ 45 = thread M45x0.75
length 40.5 ... 69.5 mm

└ 55 = thread M55x0.75
length 51 ... 80 mm

Lens Adapters and Extension Rings M45x0.75

Lens Adapter M45x0.75 to M39x1/26 (Leica)

Order Code
M39-45

length L=3.7 mm

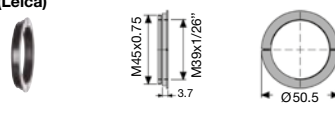

Adapter M45 x 0.75 46 mm to AM43

Order Code
AM43-M45-S L=20 mm
AM43-M45 L=35 mm

The AM43-M45 accepts the V-groove lens adapter M39x26G-AC43.



Lens Adapter V-Groove AC43 to M39x1/26"

Order Code
M39x26G-AC43-S L=1.5 mm
M39x26-AC43 L=8.2 mm

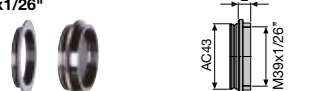

Extension Ring M45x0.75

ZR-L... Order Code

15 = length 15 mm
25 = length 25 mm
60 = length 60 mm
87 = length 87 mm

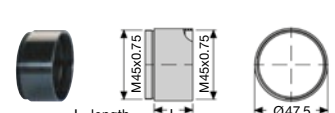

Lens Adapters and Extension Rings M55x0.75

Lens adapter 46 mm V-groove – M55 x 0.75
for macro lens inspec.x L5.6/105

AC46-55 Order Code

The Adapter AC46-55 adds 17.5 mm to the optical tube length. It accepts the AC46 V-groove of the Inspec.x macro lenses.

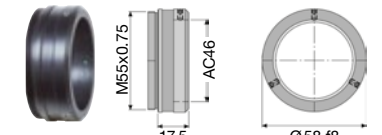

Extension Ring M55x0.75

ZR55-... Order Code

15 = length 15 mm
25 = length 25 mm
60 = length 60 mm

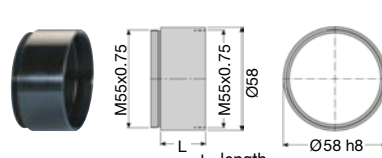

Line Scan Camera SK7500GTO-4XL - Accessories.indd