

Line Scan Camera SK4096U3PD-L

Digital camera with 50 MHz digital output
and very high line frequencies



Specifications

Sensor type:	CCD Monochrome Sensor	min. exposure time:	0.01 ms
Pixel number:	4096	max exposure time:	20 ms
Pixel size:	10 x 10 μm^2	Video signals:	monochrome 8/12 Bit digital
Pixel distance:	10 μm	Signal in/out:	USB 3.0
Active sensor length:	41 mm	Power supply:	USB (700 mA)
max. pixel frequency:	50 MHz	Size:	$\varnothing 65 \times 120 \times 53.7 \text{ mm}^3$
max. line frequency:	11.9 kHz	Case type:	AT3
Anti blooming:	x	Mass:	0.2 kg
Integration Control:	x	Lens mount:	M45x0.75
Shading correction:	x	Seat for bracket:	$\varnothing 47.5 \text{ mm}$
Threshold mode:	-	Flange focal length:	19.5 mm
Spectral sensitivity:	400 - 1000 nm	Operating temperature:	+5 ... +45°C
Dynamic range:	1:2500 (rms)		

Dimensions

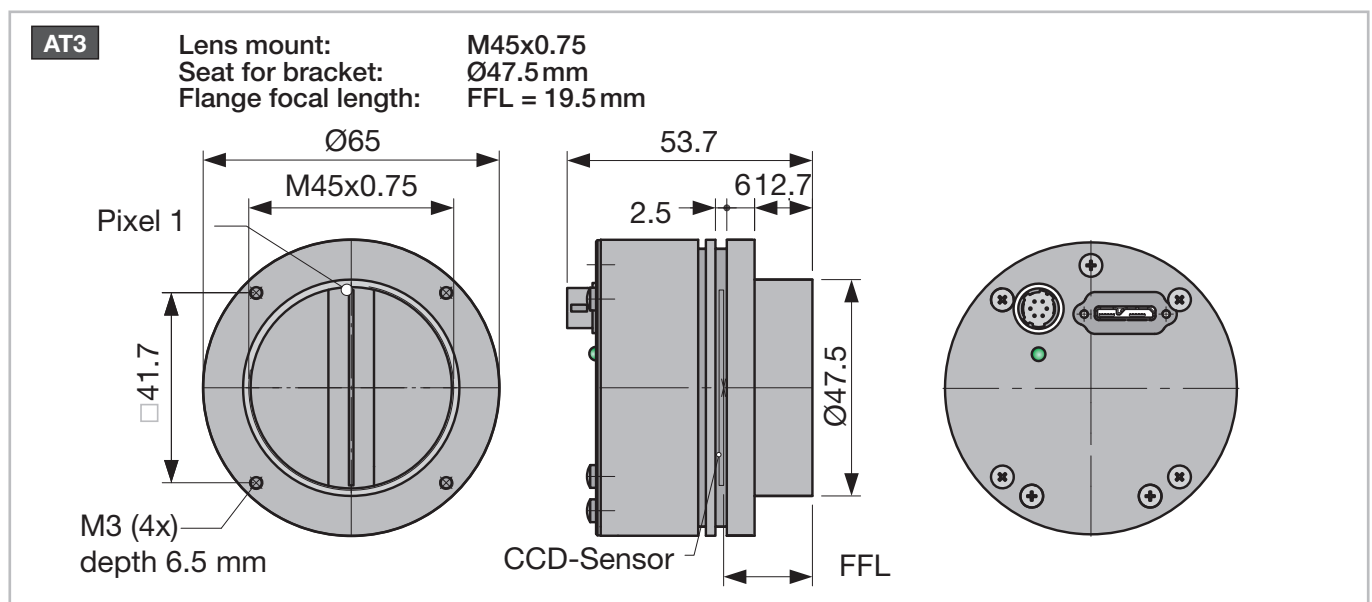

Software



Software
SK91USB3-WIN Order Code

SDK from Schäfter + Kirchhoff including the **SKLineScan** operating program, as well as libraries and examples.

Operating systems:
 Windows 7 (x64 and x86), Windows XP (SP3)

SK91USB3-LV VI Order Code

VI-Library for LabVIEW®, requires **SK91GigE-WIN**

Accessories



USB 3.0 cable SK9020.x

Camera connector: USB 3.0 plug, type micro-B, with safety lock screws

PC connector: USB 3.0 plug, type A (also fits into a USB 2.0 type A socket)

SK9020.x Order Code

└── 3 = 3 m cable length (standard)
 └── 5 = 5 m cable length



External synchronization cable SK9026...

for line scan cameras with USB 3.0 interface.

Shielded cable with Hirose plug HR10A, female 6 pin (camera side), and Phoenix 4 pin connector incl. terminal block.

SK9024.x Order Code

└── cable length 3 / 5 m
 └── Other lengths on request

M2 Mounting Bracket SK5105-L

For cameras with lens thread size M45x0.75

Order Code
SK5105-L

SK5105-L with clamping set SK5101#





MC2 Clamping Set SK5101

Clamp Order Code
SK5101
 (set of 4 pcs.)

Allen screw DIN 912-M3x12

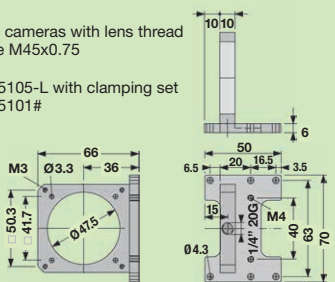

M4 Mounting System SK5105-2L

Order Code
SK5105-2L

For camera configurations with tube length > 55 mm using extension rings **ZR-L**



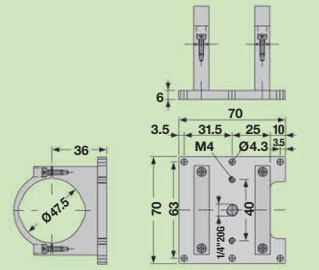



FA3 Focus adapter L-Mount (M39x1/26" Leica)

any rotation angle adjustable (V-groove)
 attachment thread M45x0.75, male

FA22R-45 Order Code
 length L: 22 ... 32 mm



FA22RL-45 Order Code
 length L: 29 ... 38 mm



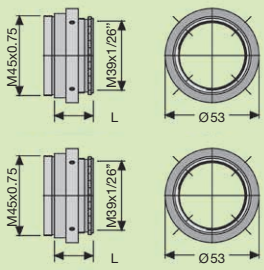

A3 Lens Adapter F-Mount

for line scan cameras with case type **Axx** or **BGx**

AOC-F-... Order Code

Attachment thread:
 45 = M45x0.75
 40 = M40x0.75
 32 = M32x0.75
 C = C-Mount 1"-32-TP



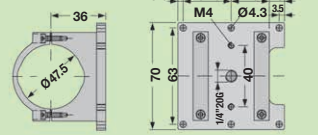

ZR-L Extension rings M45x0.75

attachment threads M45x0.75 male/female

ZR-L 25 Order Code

└── 15 = Length 15 mm
 └── 25 = Length 25 mm
 └── 60 = Length 60 mm
 └── 87 = Length 87 mm

