

## Line Scan Camera SK4096U3FD-L

CCD

monochrome

USB 3.0

Digital camera with 120 MHz digital output and very high line frequency



### ■ Sensor Characteristics

Sensor type:	CCD, Monochrome
Pixel number:	4096
Pixel size:	10 x 10 $\mu\text{m}^2$
Active sensor length:	41 mm
Pixel frequency:	120 / 60 MHz
Max. line frequency:	27.777 kHz
Min. integration time:	0.01 ms
Max. integration time:	20 ms
Spectral range:	400 - 1000 nm
Dynamic range:	1:2000 (rms)

### ■ Mechanical data

Case type:	AT3
Size:	$\text{Ø}65 \text{ mm} \times 53.7 \text{ mm}$
Mass:	0.2 kg
Lens mount:	M45x0.75
Flange focal length (FFL):	19.5 mm
Seat for bracket:	$\text{Ø}47.5 \text{ mm}$

### ■ Functioning Features

Blooming protection:	x
Integration control:	x
Shading correction:	x
Look-up table:	x
Region of interest (ROI):	x
Thresholding:	x
Temperature sensor:	x
External synchronization:	x
Operating temperature:	+5 ... +45°C

### ■ Connections

Interface:	USB 3.0
	Type $\mu\text{B}$ , threaded
Video signals:	monochrome 8/12 Bit digital
Power supply:	+5/+15V DC, 5.0 W
External synchronization:	TTL
(for power supply and external synchronization)	Hirose 10A, 6-pin, male

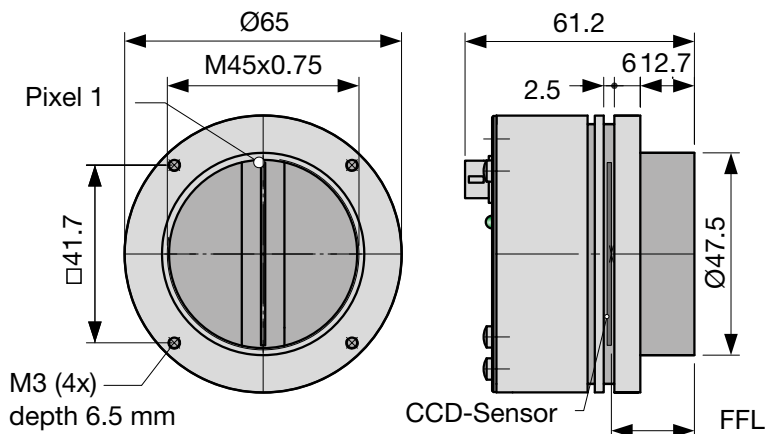

## Software

**Software**



**SK91USB3-WIN** Order Code

SDK from Schäfter + Kirchhoff including the **SKLineScan** operating program, as well as API, C++ class library and examples.

Operating systems:  
Windows 7 / 8.1 / 10 - x64 and x86

**SK91USB3-LV VI** Order Code

VI-Library for LabVIEW®, requires **SK91USB3-WIN**





**Software**

**SK91USB3-LX** Order Code

SDK from Schäfter + Kirchhoff including the **SKLineScan** operating program, as well as libraries and examples.

Operating systems:  
Linux kernel 3.13 or higher

## Accessories

**USB 3.0 cable SK9020.x**

Camera connector: USB 3.0 plug, type micro-B, with safety lock screws

PC connector: USB 3.0 plug, type A (also fits into a USB 2.0 type A socket)

**SK9020.x** Order Code

└── 3 = 3 m cable length (standard)  
    5 = 5 m cable length



**Power supply unit PS051515**

Input: 100-240 VAC, 0.8 A, 50/60 Hz  
IEC 60320 C14 coupler (for IEC C13 power cord)

Output: +5VDC, 2.5 A / +15 VDC, 0.5 A / -15 VDC, 0.3 A



Cable length: 1 m, with Lumberg connector KV60, female 6-pin

**PS051515** Order Code

**Power cord IEC 60320 C13, 1.5 m, 10 A, 250 VAC**

**PC150DE** Order Code

└── DE = Europe / US = USA, Canada, Japan / UK = United Kingdom





**USB 3.0 active extension cable USB3.EXT.AA10**

External power supply +5VDC, length 10 m

Connectors:  
1x socket USB3.0 socket, type A,  
1x plug Power in, 5VDC,  
1x plug USB3.0, type A (also fits a USB2.0 type A socket)

**USB3.EXT.AA10** Order Code





**Combined Synchronization and Power Cable SK9016.1.5**

Applicable when a power supply in addition to the USB interface is required. Shielded cable, length 1.5 m.

Connectors: Hirose plug HR10A, female 6-pin, (camera side), Lumberg SV60, male 6-pin connector (for supply voltage), Phoenix 6-pin connector incl. terminal block (for synchronization signals)

**SK9016.1.5** Order Code



**USB 3.0 active extension cable USB3.EXT.A2A...**

Hybrid cable (copper/fiber), power supply by another USB-connection, cable length up to 100 m on request.

Connectors:  
USB3.0 plug and socket, with locking screws

**USB3.EXT.A2Ax** Order Code

└── 20 = 20 m cable length  
    30 = 30 m  
    50 = 50 m  
    other lengths up to 100 m on request



**Adapter cable for sync signals CAB-ADSync-BNC-1**

BNC/SMA (3x) to line scan camera synchronization cable SK9016/SK9024/SK9026.

Shielded cable, length 0.25 m

Connectors:  
1x Phoenix 4-pin connector  
3x SMA plug (Line Sync A, Line Sync B, Frame Sync)  
3x adapter SMA socket (outside threading) to BNC-plug

**CAB-ADSync-BNC-1** Order Code



**M2 Mounting Bracket SK5105-L**

For cameras with lens thread size M45x0.75

**SK5105-L** Order Code

SK5105-L with clamping set SK5101#

**MC2 Clamping Set SK5101**

Clamp **SK5101** Order Code (set of 4 pcs.)

Allen screw DIN 912-M3x12

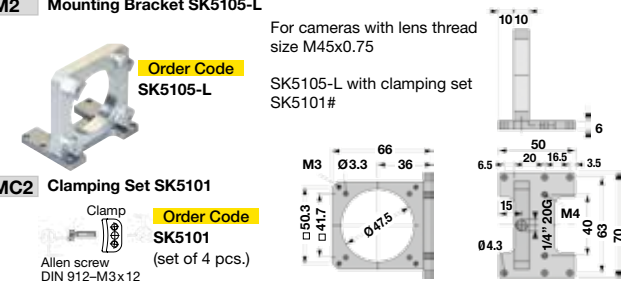

**M4 Mounting System SK5105-2L**

**SK5105-2L** Order Code

For camera configurations with tube length > 55 mm using extension rings **ZR-L**

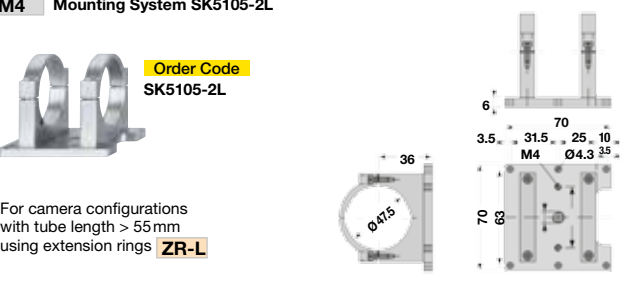

**FA3 Focus adapter L-Mount (M39x1/26" Leica)**

any rotation angle adjustable (V-groove)  
attachment thread M45x0.75, male

**FA22R-45** Order Code  
length L: 22 ... 32 mm

**FA22RL-45** Order Code  
length L: 29 ... 38 mm

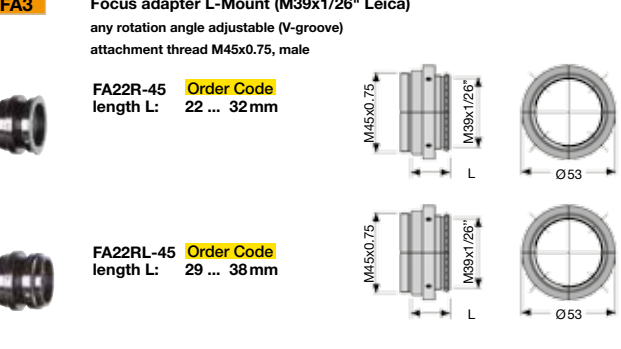

**A3 Lens Adapter F-Mount**

for line scan cameras with case type **Axx** or **BGx**.

AOC-F-... Order Code

Attachment thread:  
45 = M45x0.75  
40 = M40x0.75  
32 = M32x0.75  
C = C-Mount 1"-32-TP



**ZR-L Extension rings M45x0.75**

attachment threads M45x0.75 male/female

**ZR-L.25** Order Code

└── 15 = Length 15 mm  
    25 = Length 25 mm  
    60 = Length 60 mm  
    87 = Length 87 mm

