

Line Scan Camera SK4096GPD-L

Digital camera with 50 MHz digital output
and very high line frequency



Specifications

Sensor type:	CCD Monochrome Sensor	min. exposure time:	0.01 ms
Pixel number:	4096	max exposure time:	20 ms
Pixel size:	10 x 10 μm^2	Video signals:	monochrome 8/12 Bit digital
Pixel distance:	10 μm	Signal in/out:	GigaBit Ethernet
Active sensor length:	41 mm	Power supply:	+5V, +15V
max. pixel frequency:	50 MHz	Size:	65 x 120 x 72.4 mm ³
max. line frequency:	11.9 kHz	Case type:	BG3
Anti blooming:	x	Mass:	0.3 kg
Integration Control:	x	Lens mount:	M45x0.75
Shading correction:	x	Seat for bracket:	$\text{Ø}47.5\text{mm}$
Threshold mode:	x	Flange focal length:	19.5 mm
Spectral sensitivity:	400 - 1000 nm	Operating temperature:	+5 ... +45°C
Dynamic range:	1:2000 (rms)		

Dimensions

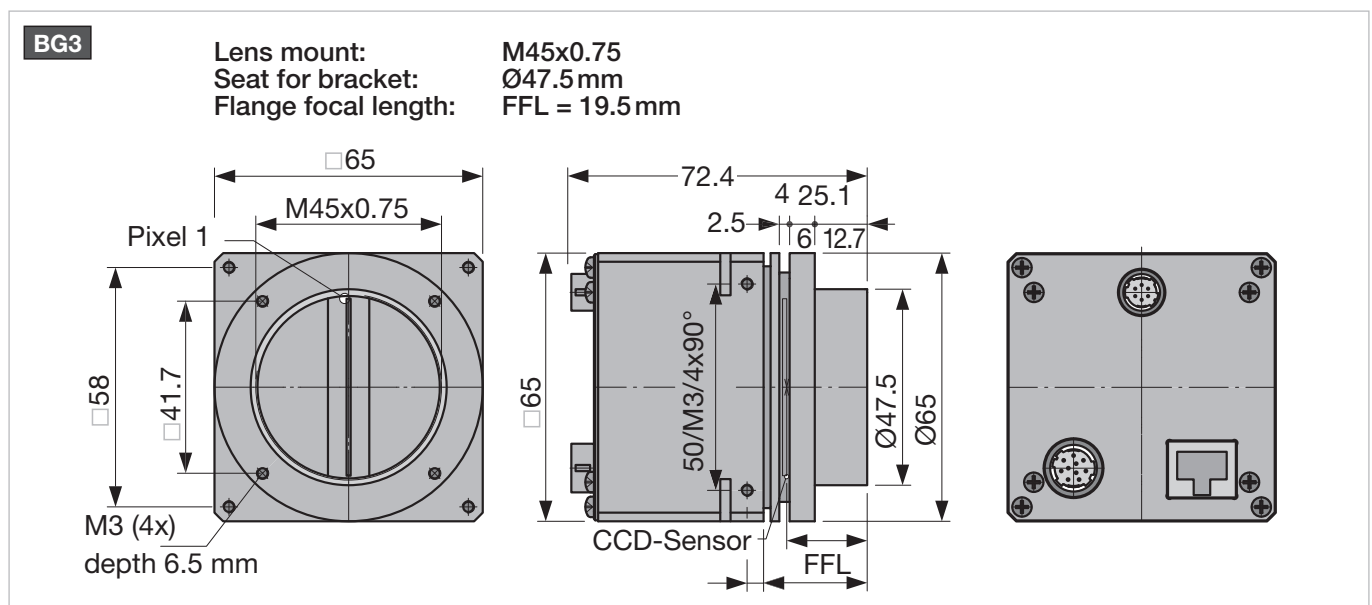

Software



Software

SK91GigE-WIN Order Code

SDK from *Schäfter + Kirchhoff* including the **SKLineScan** operating program, as well as libraries and examples.

Operating systems:
Windows 7 (x64 and x86), Windows XP (SP3)

SK91GigE-LV VI Order Code

VI-Library for LabVIEW®, requires **SK91GigE-WIN**

Accessories



Power supply unit PS051515

Input: 100-240VAC, 0.8A, 50/60Hz
IEC320 C14 coupler (for IEC C13 power cord)

Output: +5VDC, 2.5A
+15VDC, 0.5A / -15VDC, 0.3A

Cable length: 1 m, with Lumberg connector KV60, female 6-pin
PS051515 Order Code



CAT6 Network cable

Shielded CAT6 patch cable, halogen-free, both ends with RJ45 connectors for Gigabit Ethernet

CAT6.x Order Code

└ cable length 3 / 5 / 10 m or
length according to choice,
max. 100 m



Power cable SK9015.x

for GigE Vision™, CameraLink and externally supplied USB3 line scan cameras.

Shielded cable with Hirose plug HR10A, female 6-pin (camera side), and LumbergSV60, male 6-pin connector (power supply unit side).

SK9015.x Order Code

└ cable length 0.2 / 1.5 m



External synchronization cable SK9024...

for line scan cameras with GigE / GigE Vision™ interface.

Shielded cable with Hirose plug HR10A, female 12 pin (camera side), and Phoenix 4 pin connector incl. terminal block.

SK9024.x Order Code

└ cable length 3 / 5 m
Other lengths on request

M2 Mounting Bracket SK5105-L

For cameras with lens thread size M45x0.75

Order Code
SK5105-L

SK5105-L with clamping set SK5101#

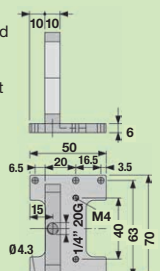

MC2 Clamping Set SK5101

Clamp **Order Code**
SK5101 (set of 4 pcs.)

Allen screw DIN 912-M3x12

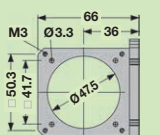

M4 Mounting System SK5105-2L

Order Code
SK5105-2L

For camera configurations with tube length > 55 mm using extension rings **ZR-L**

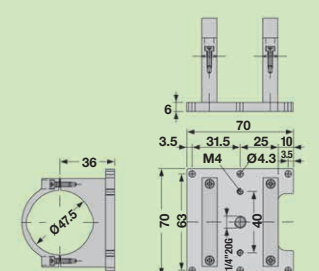

FA3 Focus adapter L-Mount (M39x1/26" Leica)

any rotation angle adjustable (V-groove)
attachment thread M45x0.75, male

FA22R-45 **Order Code**
length L: 22 ... 32 mm

FA22RL-45 **Order Code**
length L: 29 ... 38 mm

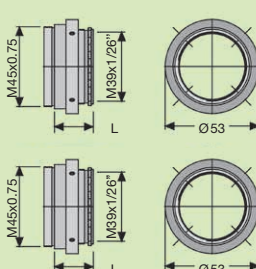

A3 Lens Adapter F-Mount

for line scan cameras with case type **Axx** or **BGx**

AOC-F-... Order Code

Attachment thread:
45 = M45x0.75
40 = M40x0.75
32 = M32x0.75
C = C-Mount 1"-32-TP



ZR-L Extension rings M45x0.75

attachment threads M45x0.75 male/female

ZR-L.25 Order Code

15 = Length 15 mm
25 = Length 25 mm
60 = Length 60 mm
87 = Length 87 mm

