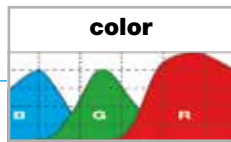

USB 3.0

- Robust cable connections
- Hot-pluggable
- Perfect for movable setups

**Schäfter + Kirchhoff**

Line Scan Camera SK22800U3JRC-XC

Digital Triple-Line CCD color camera with 3 x 7600 RGB Pixel
150 MHz pixel frequency



Specifications

Sensor type:	CCD Color Sensor
Pixel number:	3x 7600
Pixel size:	9.325 x 9.325 μm^2
Line spacing (RGB):	9.325 μm
Active sensor length:	70.87 mm
max. pixel frequency:	150 MHz
max. line frequency:	6.17 kHz
Anti blooming:	-
Integration Control:	-
Shading correction:	x
Spectral sensitivity:	350 - 680 nm
Dynamic range:	1:1000 (rms)

min. exposure time:	0.162 ms
max exposure time:	20 ms
Video signals:	color 3*8 Bit digital
Signal in/out:	USB 3.0
Power supply:	+5V, +15V
Size:	84 mm x 120 mm x 59.5 mm
Case type:	FT7
Mass:	0.4 kg
Lens mount:	M72x0.75
Seat for bracket:	\varnothing 80 mm
Flange focal length:	23.66 mm
Operating temperature:	+5 ... +45°C

Dimensions

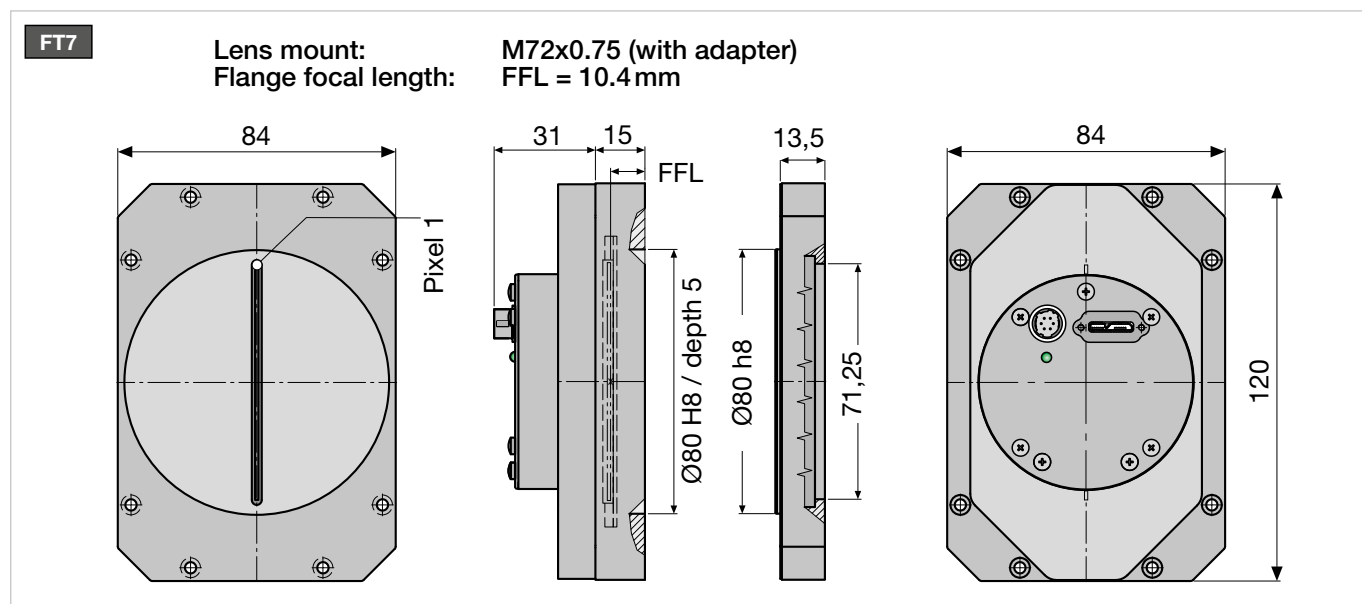

Software



Software

SK91USB3-WIN Order Code

SDK from Schäfter + Kirchhoff including the **SKLineScan** operating program, as well as API, C++ class library and examples.

Operating systems:
Windows 7 / 8.1 / 10 - x64 and x86

SK91USB3-LV VI Order Code

VI-Library for LabVIEW®, requires **SK91GigE-WIN**

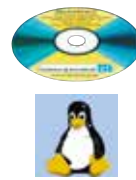

Software

SK91USB3-LX Order Code

SDK from Schäfter + Kirchhoff including the **SKLineScan** operating program, as well as libraries and examples.

Operating systems:
Linux kernel 3.13 or higher, compiled for Debian or openSUSE



Accessories



USB 3.0 cable SK9020.x

Camera connector: USB 3.0 plug, type micro-B, with safety lock screws

PC connector: USB 3.0 plug, type A (also fits into a USB 2.0 type A socket)

SK9020.x Order Code

└── 3 = 3 m cable length (standard)
 5 = 5 m cable length



Power supply unit PS051515

Input: 100-240 VAC, 0.8 A, 50/60 Hz
IEC 60320 C14 coupler (for IEC C13 power cord)

Output: +5VDC, 2.5 A / +15 VDC, 0.5 A / -15 VDC, 0.3 A

Cable length: 1 m, with Lumberg connector KV60, female 6-pin

PS051515 Order Code

Power cord IEC 60320 C13, 1.5 m, 10 A, 250 VAC

PC150DE Order Code

└── DE = Europe / US = USA, Canada, Japan /
 UK = United Kingdom







USB 3.0 active extension cable USB3.EXT.AA10

External power supply +5VDC, length 10 m

Connectors:
1x socket USB3.0 socket, type A,
1x plug Power in, 5VDC,
1x plug USB3.0, type A (also fits a USB2.0 type A socket)



USB3.EXT.AA10 Order Code



Combined Synchronization and Power Cable SK9016.1.5

Applicable when a power supply in addition to the USB interface is required. Shielded cable, length 1.5 m.

Connectors: Hirose plug HR10A, female 6 pin, (camera side), Lumberg SV60, male 6-pin connector (for supply voltage), Phoenix 6 pin connector incl. terminal block (for synchronization signals)

SK9016.1.5 Order Code



USB 3.0 active extension cable USB3.EXT.A2Ax

Hybrid cable (copper/fiber), power supply by another USB-connection, cable length up to 100 m on request.

Connectors:
USB3.0 plug and socket, with locking screws

USB3.EXT.A2Ax Order Code

└── 20 = 20 m cable length
 30 = 30 m
 50 = 50 m
 other lengths up to 100 m on request



Adapter cable for sync signals CAB-ADSync-BNC-1

BNC/SMA (3x) to Line Scan Camera Synchronization Cable SK9016/SK9024/SK9026.

Shielded cable, length 0.25 m

Connectors:
1x Phoenix 4-pin connector
3x SMA plug (Line Sync A, Line Sync B, Frame Sync)
3x adapter SMA socket (outside threading) to BNC-plug

CAB-ADSync-BNC-1 Order Code



Fokus Adapter FA26-Sx Order Code

High-precision adapter with linear tracking rods for precise travel of the focussing encasement and for locking focus position. Focussing range 30 mm, 1 turn of the focussing ring corresponds to 10 mm. Screws for focus locking.

FA26-Sx Order Code

└── 45 = thread M45x0.75
 55 = thread M55x0.75



Lenses

- high resolution scan and macro lenses

Lens Adapters, thread M45x0.75

- M39x1/26" / AC43

Lens Adapters, thread M55x0.75

- M55x1/26" / AC46

Extension rings, thread M45x0.75

ZR-L-x Order Code

└── length 15 / 25 / 60 / 87 mm

Extension rings, thread M55x0.75

M55-L-x Order Code

└── length 15 / 25 / 60 mm