

Line Scan Camera SK22368VTOC-LA

Digital Triple-Line CCD color camera with 3 x 7456 RGB Pixel
120 MHz pixel frequency



Specifications

Sensor type:	CCD Color Sensor	min. exposure time:	0.195 ms
Pixel number:	3x 7456	max exposure time:	20 ms
Pixel size:	4.7 x 4.7 μm^2	Video signals:	color 3*8 Bit digital
Line spacing (RGB):	18.8 μm	Signal in/out:	GigE Vision
Active sensor length:	35.04 mm	Power supply:	+5V, +15V
max. pixel frequency:	120 MHz	Size:	65 x 120 x 72.4 mm ³
max. line frequency:	5.13 kHz	Case type:	BG3
Anti blooming:	-	Mass:	0.3 kg
Integration Control:	-	Lens mount:	M45x0.75
Shading correction:	x	Seat for bracket:	Ø47.5mm
Threshold mode:	-	Flange focal length:	19.5 mm
Spectral sensitivity:	350 - 700 nm	Operating temperature:	+5 ... +45°C
Dynamic range:	1:1000 (rms)		

Dimensions

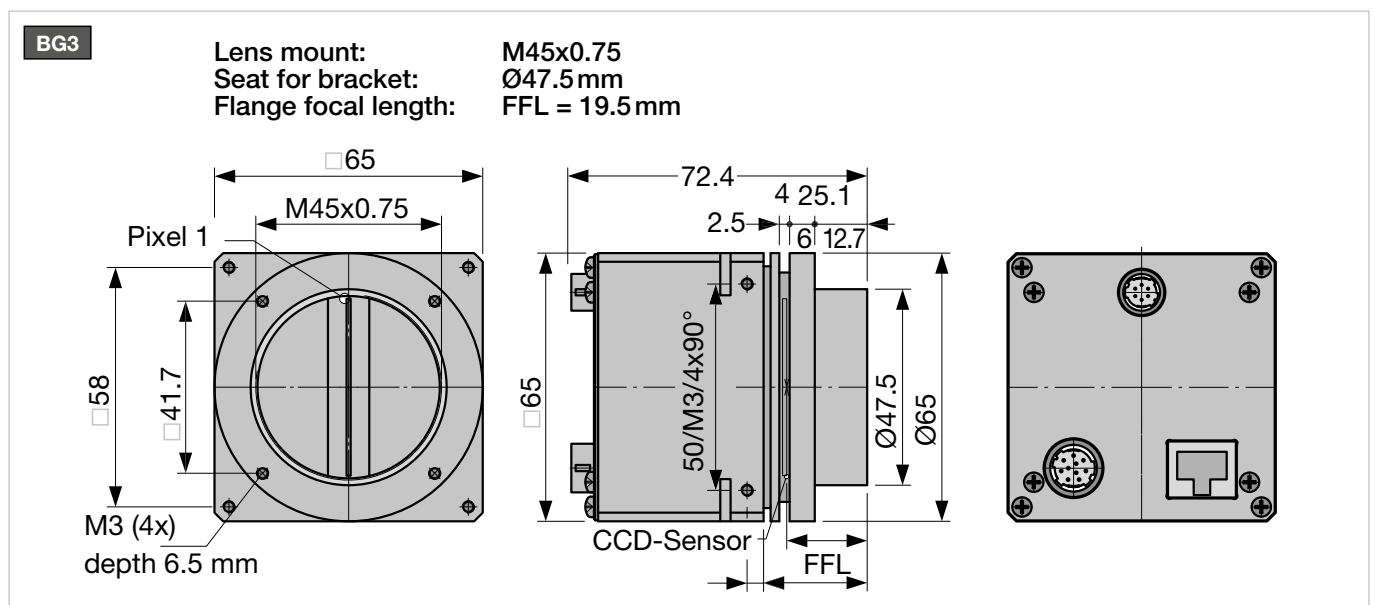

Software

Accessories



Power supply unit PS051515

Input: 100-240VAC, 0.8A, 50/60Hz
IEC320 C14 coupler (for IEC C13 power cord)

Output: +5VDC, 2.5A
+15VDC, 0.5A / -15VDC, 0.3A

Cable length: 1 m, with Lumberg connector KV60, female 6-pin

PS051515 **Order Code**



CAT6 Network cable

Shielded CAT6 patch cable, halogen-free, both ends with RJ45 connectors for Gigabit Ethernet

CAT6.x **Order Code**

└ cable length 3 / 5 / 10 m or length according to choice, max. 100 m



Power cable SK9015.x

for GigE Vision™, CameraLink and externally supplied USB3 line scan cameras.

Shielded cable with Hirose plug HR10A, female 6-pin (camera side), and LumbergSV60, male 6-pin connector (power supply unit side).

SK9015.x **Order Code**

└ cable length 0.2 / 1.5 m



External synchronization cable SK9024...

for line scan cameras with GigE / GigE Vision™ interface.

Shielded cable with Hirose plug HR10A, female 12 pin (camera side), and Phoenix 4 pin connector incl. terminal block.

SK9024.x **Order Code**

└ cable length 3 / 5 m
Other lengths on request

M2 Mounting Bracket SK5105-L

For cameras with lens thread size M45x0.75

Order Code
SK5105-L

SK5105-L with clamping set SK5101#

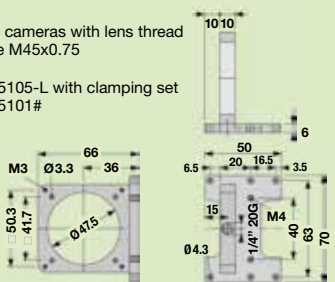

MC2 Clamping Set SK5101

Clamp **Order Code**
SK5101 (set of 4 pcs.)

Allen screw DIN 912-M3x12

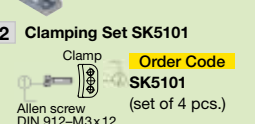

M4 Mounting System SK5105-2L

Order Code
SK5105-2L

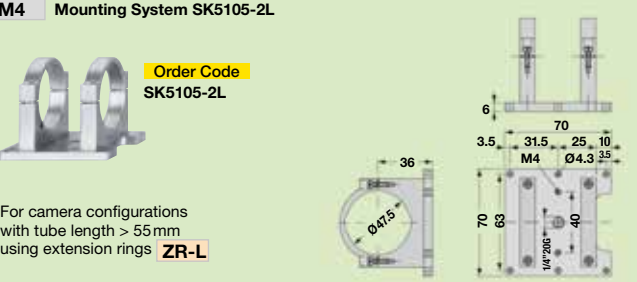

For camera configurations with tube length > 55 mm using extension rings **ZR-L**

FA3 Focus adapter L-Mount (M39x1/26" Leica)

any rotation angle adjustable (V-groove)
attachment thread M45x0.75, male

FA22R-45 **Order Code**
length L: 22 ... 32 mm

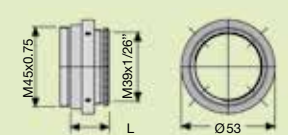

FA22RL-45 **Order Code**
length L: 29 ... 38 mm

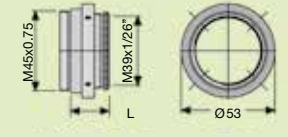

A3 Lens Adapter F-Mount

for line scan cameras with case type **Axx** or **BGx**

AOC-F-... **Order Code**

Attachment thread:
45 = M45x0.75
40 = M40x0.75
32 = M32x0.75
C = C-Mount 1"-32-TP



ZR-L Extension rings M45x0.75

attachment threads M45x0.75 male/female

ZR-L.25 **Order Code**

15 = Length 15 mm
25 = Length 25 mm
60 = Length 60 mm
87 = Length 87 mm

