

Line Scan Camera SK2048GHA

Digital camera with 120 MHz digital output
and very high line frequencies



Specifications

Sensor type:	CCD Monochrome Sensor	min. exposure time:	0.01 ms
Pixel number:	2048	max exposure time:	20 ms
Pixel size:	8 x 8 μm^2	Video signals:	monochrome 8/12 Bit digital
Pixel distance:	8 μm	Signal in/out:	GigaBit Ethernet
Active sensor length:	16.38 mm	Power supply:	+5V, +15V
max. pixel frequency:	120 MHz	Size:	65 mm x 65 mm x 71.1 mm
max. line frequency:	52.63 kHz	Case type:	BG1
Anti blooming:	x	Mass:	0.3 kg
Integration Control:	x	Lens mount:	C-Mount
Shading correction:	x	Seat for bracket:	$\text{Ø}47.5\text{mm}$
Threshold mode:	x	Flange focal length:	17.53 mm
Spectral sensitivity:	200 - 900 nm	Operating temperature:	+5 ... +45°C
Dynamic range:	1:2500 (rms)		

Dimensions

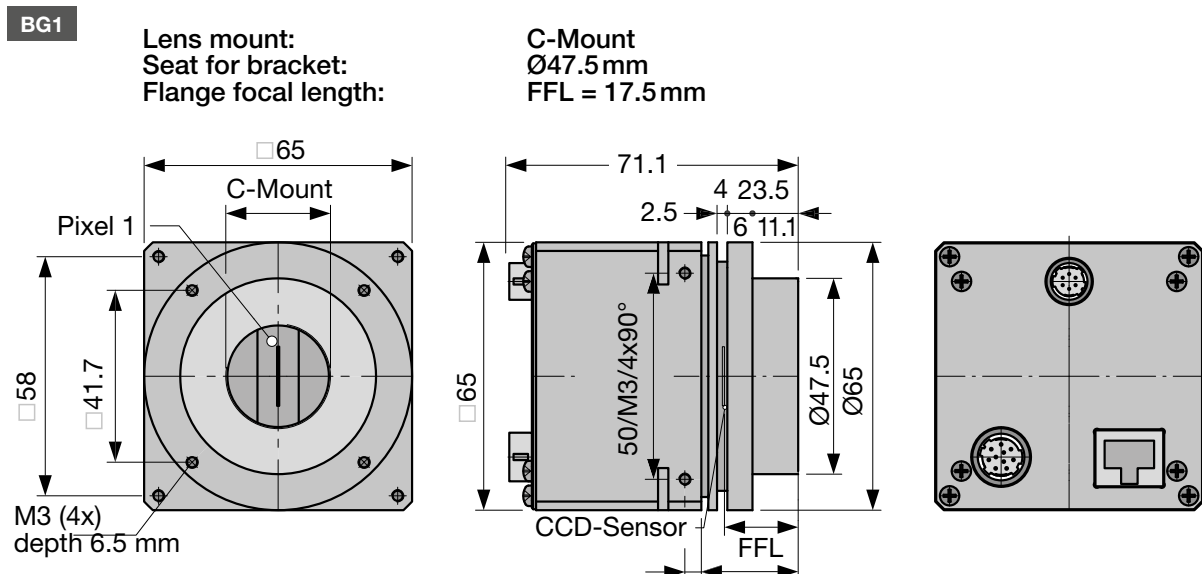

Software



Software

SK91GigE-WIN Order Code

SDK from *Schäfter + Kirchhoff* including the **SKLineScan** operating program, as well as API, C++ class library and examples.

Operating systems:
Windows 7 / 8.1 / 10 - x64 and x86

SK91GigE-LV VI Order Code

VI-Library for LabVIEW®, requires **SK91GigE-WIN**

Accessories



Power supply unit PS051515

Input: 100-240VAC, 0.8A, 50/60Hz
IEC320 C14 coupler (for IEC C13 power cord)

Output: +5VDC, 2.5A
+15VDC, 0.5A / -15VDC, 0.3A

Cable length: 1 m, with Lumberg connector KV60, female 6-pin

PS051515 Order Code



CAT6 Network cable

Shielded CAT6 patch cable, halogen-free, both ends with RJ45 connectors for Gigabit Ethernet

CAT6.x Order Code

_____ cable length 3 / 5 / 10 m or length according to choice, max. 100 m



Power cable SK9015.x

for GigE Vision™, CameraLink and externally supplied USB3 line scan cameras.

Shielded cable with Hirose plug HR10A, female 6-pin (camera side), and Lumberg SV60, male 6-pin connector (power supply unit side).

SK9015.x Order Code

_____ cable length 0.2 / 1.5 m



External synchronization cable SK9024...

for line scan cameras with GigE / GigE Vision™ interface.

Shielded cable with Hirose plug HR10A, female 12 pin (camera side), and Phoenix 4 pin connector incl. terminal block.

SK9024.x Order Code

_____ cable length 3 / 5 m
Other lengths on request

M2 Mounting Bracket SK5105-L

For cameras with lens thread size M45x0.75

Order Code SK5105-L

SK5105-L with clamping set SK5101#

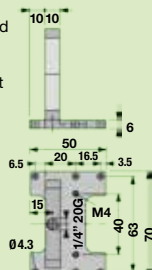

MC2 Clamping Set SK5101

Order Code SK5101

(set of 4 pcs.)

Allen screw DIN 912-M3x12

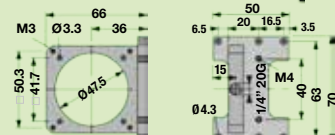

M4 Mounting System SK5105-2L

Order Code SK5105-2L

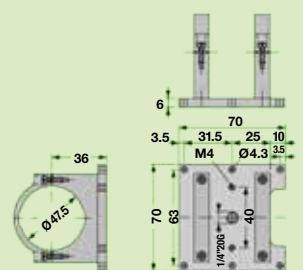

For camera configurations with tube length > 55 mm using extension rings **ZR-L**

FA1 Focus adapter FA22...

FA22-x Order Code

42 = M42 x 1
40 = M40 x 0.75
39 = M39 x 1/26"
32 = M32 x 0.75
C = C-Mount

length L: 22 ... 32 mm

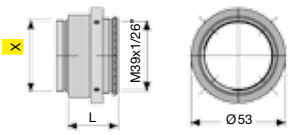

A3

Lens Adapter F-Mount

for line scan cameras with case type **Axx** or **BGx**.

AOC-F-... Order Code

Attachment thread:
45 = M45x0.75
40 = M40x0.75
32 = M32x0.75
C = C-Mount 1"-32-TP



ZR Extension rings L-Mount (M39x1/26" Leica)

attachment threads M39x1/26" male/female

ZR 10 Order Code

10 = Length 10 mm
15 = Length 15 mm
20 = Length 20 mm
50 = Length 50 mm

