

## Line Scan Camera SK16080U3JRC-L

CCD

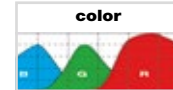

USB 3.0

Color line scan camera (Triple-Line) with 3 x 5360 RGB pixels  
24 MHz pixel frequency, integration control



### Sensor Characteristics

Sensor type:	CCD, Color
Pixel number:	3 x 5360
Pixel size:	8 x 8 $\mu\text{m}^2$
Active sensor length:	42.9 mm
Pixel frequency:	24 / 15 MHz
Max. line frequency:	1.468 kHz
Min. integration time:	0.01 ms
Max. integration time:	20 ms
Spectral range:	400 - 700 nm
Dynamic range:	1:2000 (rms)
Line spacing (RGB):	64 $\mu\text{m}$
Line color sequence:	red (R), green (G), blue (B)

### Mechanical data

Case type:	AT3
Size:	$\text{Ø}65 \text{ mm} \times 53.7 \text{ mm}$
Mass:	0.2 kg
Lens mount:	M45x0.75
Flange focal length (FFL):	19.5 mm
Seat for bracket:	$\text{Ø}47.5 \text{ mm}$

### Functioning Features

Anti blooming:	-
Integration control:	x
Shading correction:	x
Look-up table:	x
Region of interest (ROI):	x
Thresholding:	-
Temperature sensor:	x
External synchronization:	x
Operating Temperature:	+5 ... +45°C

### Connections

Interface:	USB 3.0
	Type $\mu\text{B}$ , threaded
Video signals:	color 8/12 Bit digital
Power supply:	via USB3 interface 2.5W
External synchronization:	TTL
	Hirose 10A, 6-pin, male

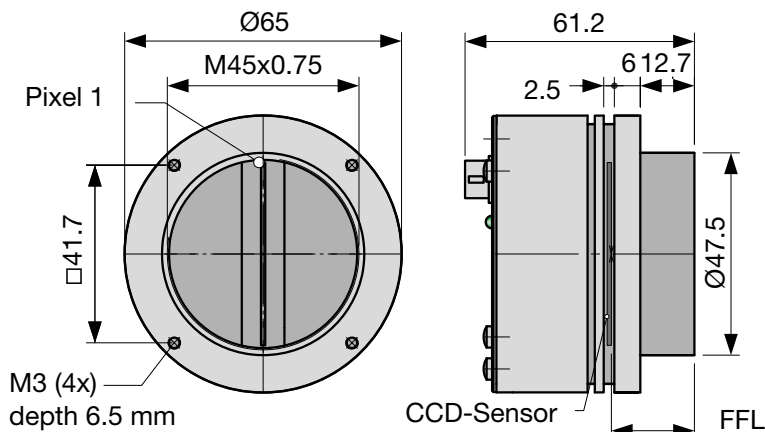

## Software



**Software**

**SK91USB3-WIN** Order Code

SDK from Schäfter + Kirchhoff including the **SKLineScan** operating program, as well as API, C++ class library and examples.

Operating systems:  
Windows 7 / 8.1 / 10 - x64 and x86

**SK91USB3-LV VI** Order Code

VI-Library for LabVIEW®, requires **SK91USB3-WIN**



**Software**

**SK91USB3-LX** Order Code

SDK from Schäfter + Kirchhoff including the **SKLineScan** operating program, as well as libraries and examples.

Operating systems:  
Linux kernel 3.13 or higher

## Accessories



**USB 3.0 cable SK9020.x**

Camera connector: USB 3.0 plug, type micro-B, with safety lock screws

PC connector: USB 3.0 plug, type A (also fits into a USB 2.0 type A socket)

**SK9020.x** Order Code

└── 1 = 1 m cable length

└── 3 = 3 m cable length (standard)



**External synchronization cable SK9026...**

for line scan cameras with USB3.0 interface.

Shielded cable with Hirose plug HR10A, female 6-pin (camera side), and Phoenix 4-pin connector incl. terminal block.

**SK9026.x** Order Code

└── cable length 3 / 5 m

Other lengths on request



**USB 3.0 active extension cable USB3.EXT.AA10**

External power supply +5VDC, length 10m

Connectors:  
1x socket USB3.0 socket, type A,  
1x plug Power in, 5VDC,  
1x plug USB3.0, type A (also fits a USB2.0 type A socket)

**USB3.EXT.AA10** Order Code



**Adapter cable for sync signals CAB-ADSync-BNC-1**

BNC/SMA (3x) to line scan camera synchronization cable SK9016/SK9024/SK9026.

Shielded cable, length 0.25m

Connectors:  
1x Phoenix 4-pin connector  
3x SMA plug (Line Sync A, Line Sync B, Frame Sync)  
3x adapter SMA socket (outside threading) to BNC-plug

**CAB-ADSync-BNC-1** Order Code



**USB 3.0 active extension cable USB3.EXT.A2A...**

Hybrid cable (copper/fiber), power supply by another USB-connection, cable length up to 100m on request.

Connectors:  
USB3.0 plug and socket, with locking screws

**USB3.EXT.A2Ax** Order Code

└── 20 = 20 m cable length

└── 30 = 30 m

└── 50 = 50 m

other lengths up to 100m on request

**M2 Mounting Bracket SK5105-L**

Mounting diameter 47.5 mm, for cameras with square housing Bxx and round housing Ax3

**SK5105-L** Order Code

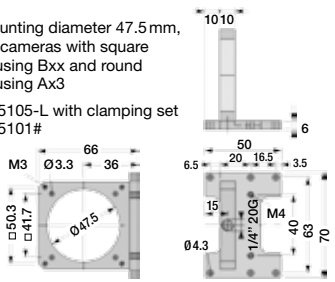

**MC Clamping Set SK5101**

Clamp **SK5101** (set of 4 pcs.) Order Code

Allen screw DIN 912-M3x12

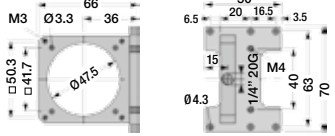

**M4 Mounting System SK5105-2L**

**SK5105-2L** Order Code

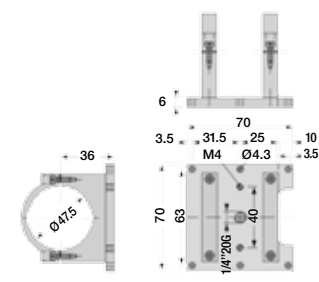

For camera configurations with tube length > 55 mm using extension rings **ZR-L**

**FA3 Focus adapter L-Mount (M39x1/26" Leica)**

any rotation angle adjustable (V-groove)

attachment thread M45x0.75, male

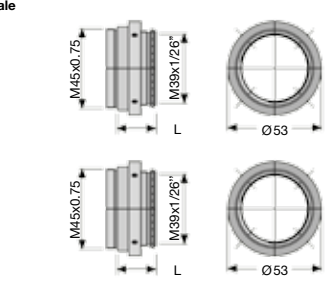

**FA22R-45** Order Code

length L: 22 ... 32 mm

**FA22RL-45** Order Code

length L: 29 ... 38 mm

**A3 Lens Adapter F-Mount**

for line scan cameras with case type **Axx** or **BGx**.



**AOC-F-...** Order Code

Attachment thread:

45 = M45x0.75

40 = M40x0.75

32 = M32x0.75

C = C-Mount 1"-32-TP

**ZR-L Extension rings M45x0.75**

attachment threads M45x0.75 male/female

**ZR-L.25** Order Code

└── 15 = Length 15 mm

└── 25 = Length 25 mm

└── 60 = Length 60 mm

└── 87 = Length 87 mm

