

Line Scan Camera SK16080GJRC-L

Digital Triple-Line CCD color camera with 3 x 5360 RGB Pixel
24 MHz pixel frequency, integration control



Specifications

Sensor type:	CCD Color Sensor	min. exposure time:	0.01 ms
Pixel number:	3x 5360	max exposure time:	20 ms
Pixel size:	8 x 8 μm^2	Video signals:	color 8/12 Bit digital
Pixel distance:	8 μm	Signal in/out:	GigaBit Ethernet
Active sensor length:	42.9 mm	Power supply:	+5V, +15V
max. pixel frequency:	24 MHz	Size:	65 mm x 65 mm x 72.4 mm
max. line frequency:	1.468 kHz	Case type:	BG3
Anti blooming:	-	Mass:	0.3 kg
Integration Control:	x	Lens mount:	M45x0.75
Shading correction:	x	Seat for bracket:	$\text{Ø}47.5\text{mm}$
Threshold mode:	-	Flange focal length:	19.5 mm
Spectral sensitivity:	400 - 700 nm	Operating temperature:	+5 ... +45°C
Dynamic range:	1:2000 (rms)		

Dimensions

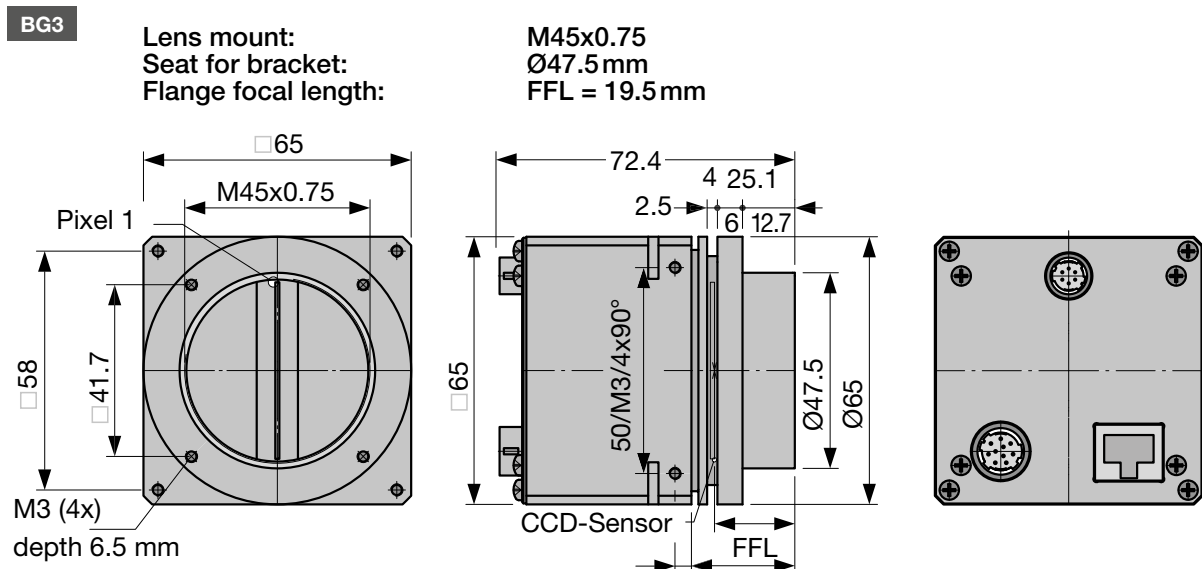

Software



Software

SK91GigE-WIN Order Code

SDK from Schäfter + Kirchhoff including the **SKLineScan** operating program, as well as API, C++ class library and examples.

Operating systems:
Windows 7 / 8.1 / 10 - x64 and x86

SK91GigE-LV VI Order Code

VI-Library for LabVIEW®, requires **SK91GigE-WIN**

Accessories



CAT6 Network cable

Shielded CAT6 patch cable, halogen-free, both ends with RJ45 connectors for Gigabit Ethernet

CAT6.x Order Code

└ cable length 3 / 5 / 10 m or length according to choice, max. 100m



Power supply unit PS051515

Input: 100-240 VAC, 0.8 A, 50/60 Hz
IEC 60320 C14 coupler (for IEC C13 power cord)

Output: +5VDC, 2.5 A / +15VDC, 0.5 A / -15VDC, 0.3 A
Cable length: 1 m, with Lumberg connector KV60, female 6-pin

PS051515 Order Code

Power cord IEC 60320 C13, 1.5 m, 10 A, 250 VAC

PC150DE Order Code

└ DE = Europe / US = USA, Canada, Japan / UK = United Kingdom



External synchronization cable SK9024.x

for line scan cameras with GigE / GigE Vision™ interface.

Shielded cable with Hirose plug HR10A, female 12 pin (camera side), and Phoenix 4 pin connector incl. terminal block.

SK9024.x Order Code

└ cable length 3 / 5 m
Other lengths on request



Power cable SK9015.x

for GigE Vision™, CameraLink and externally supplied USB3 line scan cameras.

Shielded cable with Hirose plug HR10A, female 6-pin (camera side), and Lumberg SV60, male 6-pin connector (power supply unit side).

SK9015.x Order Code

└ cable length 0.2 / 1.5 m



Adapter cable for sync signals CAB-ADSync-BNC-1

BNC/SMA (3x) to Line Scan Camera Synchronization Cable SK9016/SK9024/SK9026.

Shielded cable, length 0.25m

Connectors:
1x Phoenix 4-pin connector
3x SMA plug (Line Sync A, Line Sync B, Frame Sync)
3x adapter SMA socket (outside threading) to BNC-plug

CAB-ADSync-BNC-1 Order Code

M2 Mounting Bracket SK5105-L

For cameras with lens thread size M45x0.75

SK5105-L Order Code

SK5105-L with clamping set SK5101#

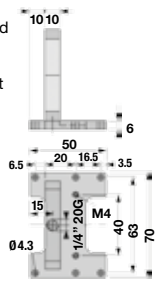

MC2 Clamping Set SK5101

Clamp **SK5101** Order Code

Allen screw DIN 912-M3x12 (set of 4 pcs.)

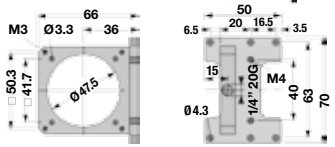

M4 Mounting System SK5105-2L

SK5105-2L Order Code

For camera configurations with tube length > 55 mm using extension rings **ZR-L**

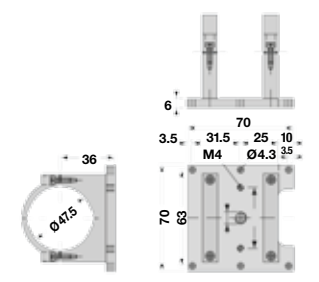

FA3 Focus adapter L-Mount (M39x1/26" Leica)

any rotation angle adjustable (V-groove)
attachment thread M45x0.75, male

FA22R-45 Order Code
length L: 22 ... 32 mm

FA22RL-45 Order Code
length L: 29 ... 38 mm

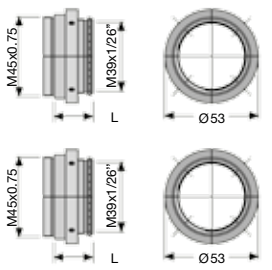

A3 Lens Adapter F-Mount

for line scan cameras with case type **Axx** or **BGx**.

AOC-F-... Order Code

Attachment thread:
45 = M45x0.75
40 = M40x0.75
32 = M32x0.75
C = C-Mount 1"-32-TP



ZR-L Extension rings M45x0.75

attachment threads M45x0.75 male/female

ZR-L.25 Order Code

15 = Length 15 mm
25 = Length 25 mm
60 = Length 60 mm
87 = Length 87 mm

