

## Line Scan Camera SK22800GJRC-4XC

CCD



Gigabit  
ETHERNET

Color line scan camera (Triple-Line) with 3 x 7600 RGB pixels, 4.93 kHz maximum line rate, high resolution.



### ■ Sensor Characteristics

Sensor type:	CCD, Color
Pixel number:	3 x 7600
Pixel size:	9.325 x 9.325 $\mu\text{m}^2$
Active sensor length:	70.87 mm
Pixel frequency:	120 / 60 MHz
Max. line frequency:	4.95 kHz
Min. integration time:	0.01 ms
Max. integration time:	20 ms
Spectral range:	350 - 680 nm
Dynamic range:	1:1000 (rms)
Line spacing (RGB):	9.325 $\mu\text{m}$
Line color sequence:	blue (B), green (G), red (R)

### ■ Mechanical data

Case type:	FG7
Size:	84 mm x 120 mm x 78.5 mm
Mass:	0.4 kg
Lens mount:	$\text{Ø}80 \text{ H}8$
Flange focal length (FFL):	10.16 mm

### ■ Functioning Features

Anti blooming:	-
Integration control:	-
Shading correction:	x
Look-up table:	x
Region of interest (ROI):	x
Thresholding:	-
Temperature sensor:	x
External synchronization:	x
Operating temperature:	+5 ... +45°C

### ■ Connections

Interface:	GigaBit Ethernet RJ-45 (8P8C)
Video signals:	color 3*8 Bit digital
Power supply:	24V DC, 8.8 W Hirose 10A, 4-pin, male
External synchronization:	TTL Hirose 10A, 12-pin, male

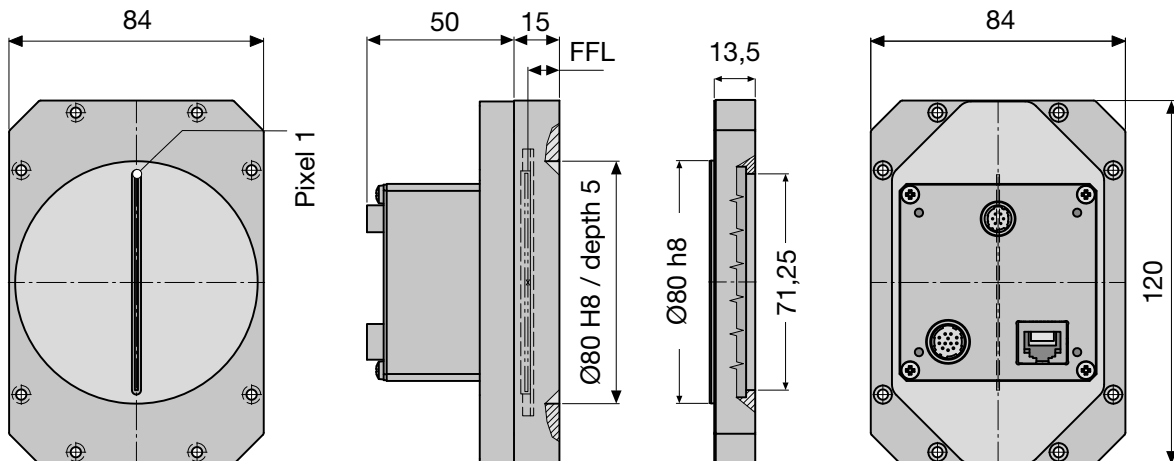

## Software



**Software**

**SK91GigE-WIN** Order Code

SDK from Schäfter + Kirchhoff including the **SKLineScan** operating program, as well as API, C++ class library and examples.

Operating systems:  
Windows 7 / 8.1 / 10 - x64 and x86

**SK91GigE-LV VI** Order Code

VI-Library for LabVIEW®, requires **SK91GigE-WIN**

## Accessories



**CAT6 Network cable**

Shielded CAT6 patch cable, halogen-free, both ends with RJ45 connectors for Gigabit Ethernet

**CAT6.x** Order Code

└ cable length 3 / 5 / 10 m or length according to choice, max. 100m



**Power supply unit PS243005**

Input: 100-240 VAC, 0.8 A, 50/60 Hz  
IEC 60320 C14 coupler (for IEC C13 power cord)  
Output: +24V DC, 3.0 A  
Cable length: 1 m, with XLR connector type NC6FFX

**PS243005** Order Code

**Power cord IEC 60320 C13, 1.5 m, 10 A, 250 V AC**

**PC150DE** Order Code

└ DE = Europe / US = USA, Canada, Japan / UK = United Kingdom



**External synchronization cable SK9024...**

for line scan cameras with GigE / GigE Vision™ interface.

Shielded cable with Hirose plug HR10A, female 12-pin (camera side), and Phoenix 4-pin connector incl. terminal block.

**SK9024.x** Order Code

└ cable length 3 / 5 m  
Other lengths on request



**Power cable SK9014.xMF**

for GigE Vision™ line scan cameras with 24 VDC supply voltage.

Shielded cable with Hirose plug HR10A, female 4-pin (camera side), and XLR connector type NC6MXX (power supply unit side).

**SK9014.xMF** Order Code

└ cable length 1.5 / 3 / 5 m



**Adapter cable for sync signals CAB-ADSync-BNC-1**

BNC/SMA (3x) to line scan camera synchronization cable SK9016/SK9024/SK9026.

Shielded cable, length 0.25 m

Connectors:  
1x Phoenix 4-pin connector  
3x SMA plug (Line Sync A, Line Sync B, Frame Sync)  
3x adapter SMA socket (outside thread) to BNC-plug

**CAB-ADSync-BNC-1** Order Code



**Power cable SK9014.xF**

for GigE Vision™ line scan cameras with 24 VDC supply voltage.

Shielded cable with Hirose plug HR10A, female 4-pin (camera side), and open-ended cable.

**SK9014.xF** Order Code

└ cable length 1.5 / 3 / 5 m



**Focus Adapter FA26-Sx**

High-precision adapter with linear tracking rods for precise travel of the focussing encasement and for locking focus position. Focussing range 29 mm, 1 turn of the focussing ring corresponds to 10 mm. Screws for focus locking.

**FA26-Sx** Order Code

└ 45 = thread M45x0.75  
length 40.5 ... 69.5 mm  
55 = thread M55x0.75  
length 51 ... 80 mm

**Lens Adapters and Extension Rings M45x0.75**

**Lens Adapter M45x0.75 to M39x1/26 (Leica)**

Order Code  
**M39-45**

length L=3.7 mm

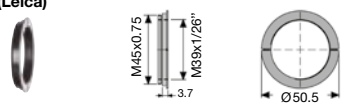

**Adapter M45 x 0.75 46 mm to AM43**

Order Code  
**AM43-M45-S** L=20 mm  
**AM43-M45** L=35 mm

The AM43-M45 accepts the V-groove lens adapter M39x26G-AC43.



**Lens Adapter V-Groove AC43 to M39x1/26"**

Order Code  
**M39x26G-AC43-S** L=1.5 mm  
**M39x26-AC43** L=8.2 mm

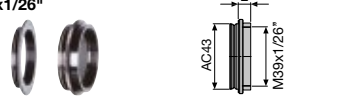

**Extension Ring M45x0.75**

**ZR-L...** Order Code

15 = length 15 mm  
25 = length 25 mm  
60 = length 60 mm  
87 = length 87 mm

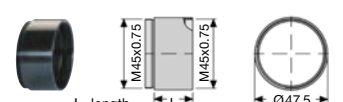

**Lens Adapters and Extension Rings M55x0.75**

**Lens adapter 46 mm V-groove – M55 x 0.75**

for macro lens inspec.x L5.6/105

**AC46-55** Order Code

The Adapter AC46-55 adds 17.5 mm to the optical tube length. It accepts the AC46 V-groove of the Inspec.x macro lenses.

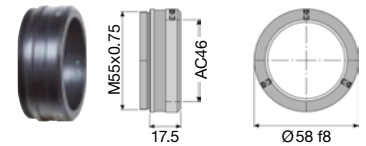

**Extension Ring M55x0.75**

**ZR55-...** Order Code

15 = length 15 mm  
25 = length 25 mm  
60 = length 60 mm

