

Line Scan Camera SK2048U3SH

CCD

monochrome

USB 3.0

Line scan camera with large dynamic range and 14.3 kHz maximum line rate, anti blooming and integration control.



■ Sensor Characteristics

Sensor type:	CCD, Monochrome
Pixel number:	2048
Pixel size:	14 x 14 μm^2
Active sensor length:	28.7 mm
Pixel frequency:	30 / 20 MHz
Max. line frequency:	14.3 kHz
Min. integration time:	0.01 ms
Max. integration time:	20 ms
Spectral range:	200 - 1000 nm
Dynamic range:	1:2000 (rms)

■ Mechanical data

Case type:	AT2
Size:	$\varnothing 65$ mm x 54 mm
Mass:	0.2 kg
Lens mount:	M40x0.75
Flange focal length (FFL):	19.5 mm
Seat for bracket:	$\varnothing 42$ mm

■ Functioning Features

Anti blooming:	x
Integration control:	x
Shading correction:	x
Look-up table:	x
Region of interest (ROI):	x
Thresholding:	x
Temperature sensor:	x
External synchronization:	x
Operating Temperature:	+5 ... +45°C

■ Connections

Interface:	USB 3.0
	Type μB , threaded
Video signals:	monochrome 8/12 Bit digital
Power supply:	via USB3 interface 3.7 W
External synchronization:	TTL
	Hirose 10A, 6-pin, male

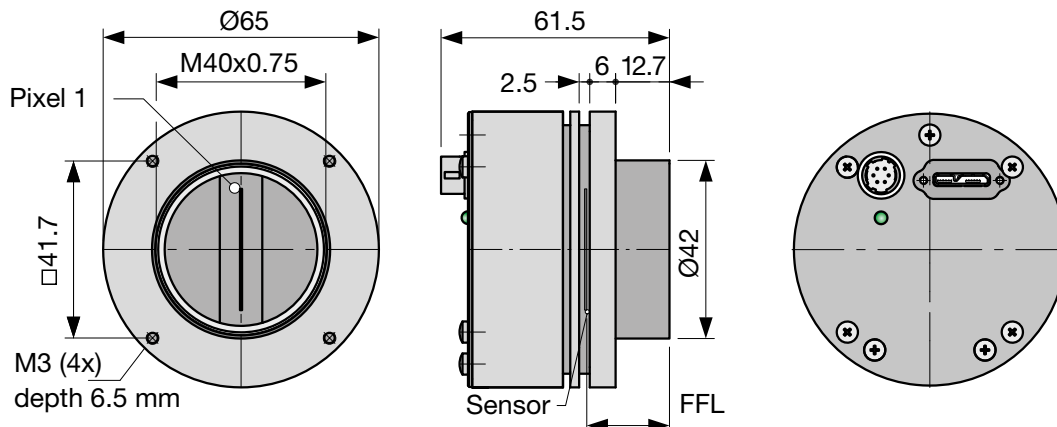

Software

Software



SK91USB3-WIN Order Code

SDK from Schäfter + Kirchhoff including the **SKLineScan** operating program, as well as API, C++ class library and examples.

Operating systems:
Windows 7 / 8.1 / 10 - x64 and x86

SK91USB3-LV VI Order Code

VI-Library for LabVIEW®, requires **SK91USB3-WIN**





Software

SK91USB3-LX Order Code

SDK from Schäfter + Kirchhoff including the **SKLineScan** operating program, as well as libraries and examples.

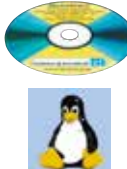
Operating systems:
Linux kernel 3.13 or higher

Accessories

USB 3.0 cable SK9020.x

Camera connector: USB 3.0 plug, type micro-B, with safety lock screws

PC connector: USB 3.0 plug, type A (also fits into a USB 2.0 type A socket)

SK9020.x Order Code

└── 1 = 1 m cable length
 3 = 3 m cable length (standard)



External synchronization cable SK9026...

for line scan cameras with USB3.0 interface.

Shielded cable with Hirose plug HR10A, female 6-pin (camera side), and Phoenix 4-pin connector incl. terminal block.

SK9026.x Order Code

└── cable length 3 / 5 m
 Other lengths on request





USB 3.0 active extension cable USB3.EXT.AA10

External power supply +5VDC, length 10m

Connectors:
1x socket USB3.0 socket, type A,
1x plug Power in, 5VDC,
1x plug USB3.0, type A (also fits a USB2.0 type A socket)

USB3.EXT.AA10 Order Code

Adapter cable for sync signals CAB-ADSync-BNC-1

BNC/SMA (3x) to line scan camera synchronization cable SK9016/SK9024/SK9026.

Shielded cable, length 0.25m

Connectors:
1x Phoenix 4-pin connector
3x SMA plug (Line Sync A, Line Sync B, Frame Sync)
3x adapter SMA socket (outside threading) to BNC-plug

CAB-ADSync-BNC-1 Order Code



USB 3.0 active extension cable USB3.EXT.A2A...

Hybrid cable (copper/fiber), power supply by another USB-connection, cable length up to 100m on request.

Connectors:
USB3.0 plug and socket, with locking screws

USB3.EXT.A2Ax Order Code

└── 20 = 20 m cable length
 30 = 30 m
 50 = 50 m
 other lengths up to 100m on request



M1 Mounting Bracket SK5105

Mounting diameter 42.0mm, for cameras with round housing Ax1 or Ax2

Order Code SK5105

MC Clamping Set SK5101

Clamp **Order Code SK5101** (set of 4 pcs.)
Allen screw DIN 912-M3x12

SK5105 with clamping set SK5102#

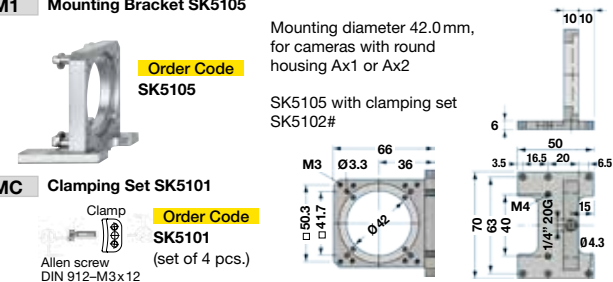

M3 Mounting System SK5105-2

Order Code SK5105-2

For camera configurations with tube length > 55mm using extension rings **ZR**

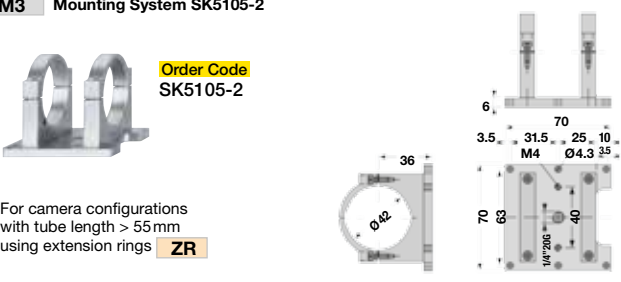

FA1 Focus adapter FA22...

FA22-x Order Code

42 = M42 x 1
40 = M40 x 0.75
39 = M39 x 1/26"
32 = M32 x 0.75
C = C-Mount

length L: **22 ... 32mm**

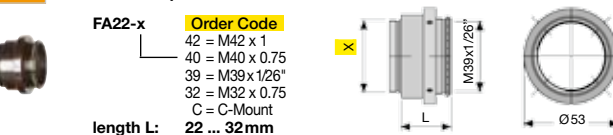

A3 Lens Adapter F-Mount

for line scan cameras with case type **Axx** or **BGx**.

AOC-F-... Order Code

Attachment thread:
45 = M45x0.75
40 = M40x0.75
32 = M32x0.75
C = C-Mount 1"-32-TP

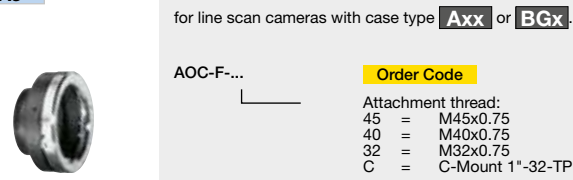

FA2 Focus adapter L-Mount (M39x1/26" Leica)

any rotation angle adjustable (V-groove) attachment thread M40x0.75, male

FA22R-40 Order Code
length L: **28 ... 38mm**

FA22RL-40 Order Code
length L: **35 ... 45mm**

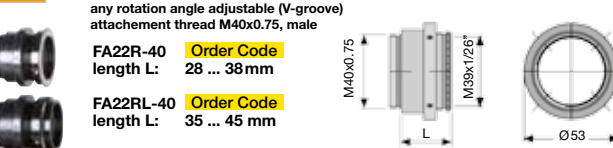

ZR Extension rings L-Mount (M39x1/26" Leica)

attachment threads M39x1/26" male/female

ZR 10 Order Code

10 = Length 10 mm
15 = Length 15 mm
20 = Length 20 mm
50 = Length 50 mm

